



Raising the Standard™

Product Catalog



Updated March 2025



Raising the Standard™

Our Story

Since 1938, Cincinnati Surgical has been recognized as an industry leader for manufacturing high quality surgical blades, scalpels, safety products, and operating room accessories. Our manufacturing heritage in the United States (1938-1961) and Sheffield, England (1962-Present) has now come under one roof in Sheffield through a historic joint manufacturing agreement with Swann-Morton. By combining our manufacturing capabilities we are able to offer our customers the following:

- Increased range of products with continued focus on design and innovation
- In-House design and build of our own specialized machinery
- ISO 13485 Certification & In-House Sterilization
- ISO 14001 Environmental Manufacturing Standards Certification
- ISO 50001 Energy Management
- Increased capacity, production capabilities, and visual quality product inspection
- Superior customer service with same day shipping

Our Portfolio

Each brand offered has its own unique shape, size, and material composition due to historical design and manufacturing processes. There are also additional differences in the available features as laid out below and throughout this catalog.

Swann-Morton®

- 200% Visual Inspection
- Packaged with VCI Paper to protect the blade from corrosion
- Strongest/Smallest Foil Package available
- Narrow Grinding Angle resulting in increased initial keenness
- High Surface Finish
- Extended Range
- CE Mark



- 200% Visual Inspection
- Packaged with VCI Paper to protect the blade from corrosion
- Strong Foil Packaging
- Narrow Grinding Angle resulting in increased initial keenness
- Medium Surface Finish
- Standard Range

 **Lance®**

- 100% Visual Inspection
- Wide Grinding Angle resulting in high durability
- Low Surface Finish
- Limited Range
- CE Mark

Terms of Trade

To Place an Order:	Phone: 513-489-6640 Toll Free: 800-544-3100 Fax: 513-489-6683 Email: po@cincinnati-surgical.com Mail: 11331 Grooms Rd., Cincinnati, Ohio 45242
Hours of Operation:	Monday – Thursday: 8:00am - 5:00pm EST Friday 8:00am – 3:00pm EST
Terms:	Net 30 days with approved credit Visa, MasterCard and American Express accepted WE DO NOT SHIP COD
Shipping and Handling:	FOB: Cincinnati, Ohio Unless otherwise specified, orders are shipped UPS or FedEx Ground, prepay and add Expedited delivery available upon request Additional handling fees may apply
Return Policy:	Returns must have an RGA. All items must be returned in original, resalable condition within 120 days from invoice date. All returns are reviewed by our customer service department and incur a 10% restocking fee. Any non-stock items or atypical volume orders will require additional approval and may be subject to a higher restocking fee.
Distribution Policy:	A \$15 processing fee will be charged on all orders under \$100.
Minimum Order Policy:	\$25 minimum order – no distribution orders under \$25 will be accepted.

Page 1

Swann-Morton

Standard Surgical Blades
Specialty Blades
Miniature Blades
Disposable Scalpels

Page 6

Cincinnati Surgical

Standard Surgical Blades
Disposable Scalpels
Miniature Scalpels

Page 10

Lance

Standard Surgical Blades
Disposable Scalpels

Page 12

Safety

KLEEN Blade Management System (Cartridge Blade)
Retracting Blade Safety Scalpels
Retracting Guard Safety Scalpels
Blade Removers
Ampoule Openers

Page 15

Stitch Cutters

Page 16

Pathology/Post Mortem

Surgical Blades
Disposable Knife

Page 17

Skin Graft

Skin Graft Blades
Disposable Scalpel
Skin Graft Handles

Page 18

Handles

Page 21

Needles

Swann-Morton is a world leader in the manufacturing of surgical blades, scalpels and handles. It is a name respected globally for quality, precision, consistency and reliability.

Product Features:

- 200% Visual Inspection
- Packaged with VCI Paper to protect the blade from corrosion
- Strongest/Smallest Foil Package available
- Narrow Grinding Angle resulting in increased initial keenness
- High Surface Finish
- CE Mark
- Largest Range

Blades



Swann Morton Blade Size 6
packaged 100/box
00SM6: sterile, carbon
01SM6: sterile, stainless
02SMV6: non-sterile carbon
(20 PK/5 VPI)



Swann Morton Blade Size 9
packaged 100/box
00SM9: sterile, carbon
01SM9: sterile, stainless



Swann Morton Blade Size 10
packaged 100/box
00SM10: sterile, carbon
01SM10: sterile, stainless
02SMV10: non-sterile carbon
(20 PK/5 VPI)



Swann Morton Blade Size 10A
packaged 100/box
00SM10A: sterile, carbon
01SM10A: sterile, stainless
02SMV10A: non-sterile carbon
(20 PK/5 VPI)



Swann Morton Blade Size 10R
packaged 100/box
01SM10R: sterile, stainless



Swann Morton Blade Size 11
packaged 100/box
00SM11: sterile, carbon
01SM11: sterile, stainless
02SMV11: non-sterile carbon
(20 PK/5 VPI)



Swann Morton Blade Size 11P
packaged 100/box
00SM11P: sterile, carbon
01SM11P: sterile, stainless
02SMV11P: non-sterile carbon
(20 PK/5 VPI)



Swann Morton Blade Size E11
packaged 100/box
00SME11: sterile, carbon
01SME11: sterile, stainless
00SMSE11: sterile, carbon,
Sabre



Swann Morton Blade Size 12
packaged 100/box
00SM12: sterile, carbon
01SM12: sterile, stainless
02SMV12: non-sterile carbon
(20 PK/5 VPI)



Swann Morton Blade Size 12D
packaged 100/box
00SM12D: sterile, carbon
01SM12D: sterile, stainless



Swann Morton Blade Size 13
packaged 100/box
00SM13: sterile, carbon
01SM13: sterile, stainless



Swann Morton Blade Size 14
packaged 100/box
00SM14: sterile, carbon
01SM14: sterile, stainless



Swann Morton Blade Size 15
packaged 100/box
00SM15: sterile, carbon
01SM15: sterile, stainless
02SMV15: non-sterile carbon
(20 PK/5 VPI)



Swann Morton Blade Size 15A
packaged 100/box
00SM15A: sterile, carbon
01SM15A: sterile, stainless



Swann Morton Blade Size 15C
packaged 100/box
00SM15C: sterile, carbon
01SM15C: sterile, stainless



Swann Morton Blade Size 15T
packaged 100/box
00SM15T: sterile, carbon
01SM15T: sterile, stainless

*Blades are not shown to actual size.



Swann Morton Blade Size 16
packaged 100/box
00SM16: sterile, carbon
01SM16: sterile, stainless



Swann Morton Blade Size 18
packaged 100/box
00SM18: sterile, carbon
01SM18: sterile, stainless



Swann Morton Blade Size 19
packaged 100/box
01SM19: sterile, stainless



Swann Morton Blade Size 20
packaged 100/box
00SM20: sterile, carbon
01SM20: sterile, stainless
02SMV20: non-sterile carbon
(20 PK/5 VPI)



Swann Morton Blade Size 21
packaged 100/box
00SM21: sterile, carbon
01SM21: sterile, stainless



Swann Morton Blade Size 22
packaged 100/box
00SM22: sterile, carbon
01SM22: sterile, stainless



Swann Morton Blade Size 22A
packaged 100/box
00SM22A: sterile, carbon
01SM22A: sterile, stainless



Swann Morton Blade Size 23
packaged 100/box
00SM23: sterile, carbon
01SM23: sterile, stainless
02SMV23: non-sterile carbon
(20 PK/5 VPI)



Swann Morton Blade Size 24
packaged 100/box
00SM24: sterile, carbon
01SM24: sterile, stainless
02SMV24: non-sterile carbon
(20 PK/5 VPI)



Swann Morton Blade Size 25
packaged 100/box
00SM25: sterile, carbon
01SM25: sterile, stainless
02SMV25: non-sterile carbon
(20 PK/5 VPI)



Swann Morton Blade Size 25A
packaged 100/box
00SM25A: sterile, carbon
01SM25A: sterile, stainless
02SMV25A: non-sterile carbon
(20 PK/5 VPI)



Swann Morton Blade Size 26
packaged 100/box
00SM26: sterile, carbon
01SM26: sterile, stainless
02SMV26: non-sterile carbon
(20 PK/5 VPI)



Swann Morton Blade Size 27
packaged 100/box
01SM27: sterile, stainless



Swann Morton Blade Size 36
packaged 100/box
00SM36: sterile, carbon



Swann Morton Blade Size 40
packaged 100/box
00SM40: sterile, carbon



*Blades are not shown to actual size.



Cervical Biopsy Blade
packaged 10/box
01C: sterile, stainless



Myringotomy Blade
packaged 10/box
01M: sterile, stainless



Podiatry Blade
packaged 5/box
PD81: non-sterile, stainless



Podiatry Blade
packaged 5/box
PD82: non-sterile, stainless



Miniature Surgical Blade Size 61
packaged 25/box
01SM61: sterile, stainless



Miniature Surgical Blade Size 61SB
packaged 25/box
01SM61SB: sterile, stainless, Single Bevel



Miniature Surgical Blade Size 62
packaged 25/box
01SM62: sterile, stainless



Miniature Surgical Blade Size 62SB
packaged 25/box
01SM62SB: sterile, stainless, Single Bevel



Miniature Surgical Blade Size 63
packaged 25/box
01SM63: sterile, stainless



Miniature Surgical Blade Size 64
packaged 25/box
01SM64: sterile, stainless



Miniature Surgical Blade Size 65
packaged 25/box
01SM65: sterile, stainless



Miniature Surgical Blade Size 65A
packaged 25/box
01SM65A: sterile, stainless



Miniature Surgical Blade Size 67
packaged 25/box
01SM67: sterile, stainless



Miniature Surgical Blade Size 68
packaged 25/box
01SM68: sterile, stainless



Miniature Surgical Blade Size 69
packaged 25/box
01SM69: sterile, stainless



Miniature Hair Transplant Surgical Blade Size 90
packaged 25/box
01SP90: sterile, stainless



Miniature Hair Transplant Surgical Blade Size 91
packaged 25/box
01SP91: sterile, stainless



*Blades are not shown to actual size.

*Scalpels are not shown to actual size.

Swann Morton Disposable Scalpel Size 9

SM0517: sterile, stainless
packaged 10/box



Swann Morton Disposable Scalpel Size 10

SM0501: sterile, stainless
packaged 10/box

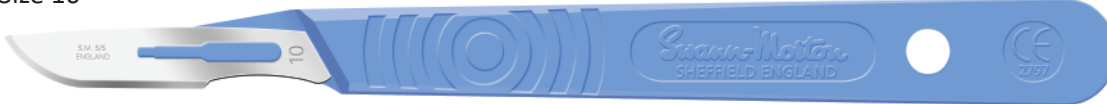

SM6601: sterile, stainless
w/guard
packaged 10/box

SM2331: non-sterile, stainless
w/guard
packaged 1000/box



Swann Morton Disposable Scalpel Size 10A

SM0502: sterile, stainless
packaged 10/box

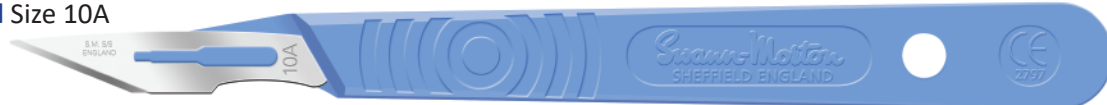

SM6602: sterile, stainless
w/guard
packaged 10/box

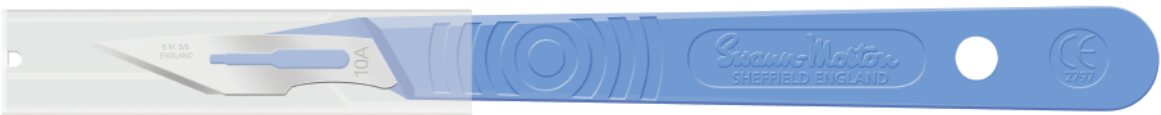

Swann Morton Disposable Scalpel Size 10R

SM6690: sterile, stainless
w/guard
packaged 10/box



Swann Morton Disposable Scalpel Size 11

SM0503: sterile, stainless
packaged 10/box



SM6603: sterile, stainless
w/guard
packaged 10/box

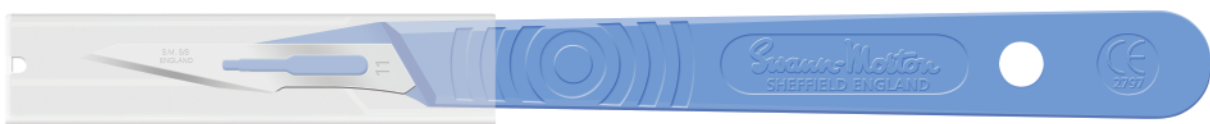

Swann Morton Disposable Scalpel Size 11P

SM0591: sterile, stainless
packaged 10/box



SM2391: non-sterile, stainless
w/guard
packaged 1000/box



*Scalpels are not shown to actual size.

Swann Morton Disposable Scalpel Size 12**SM0504:** sterile, stainless
packaged 10/box**SM6604:** sterile, stainless
w/ guard
packaged 10/box**SM2334:** non-sterile, stainless
w/ guard
packaged 1000/box**Swann Morton Disposable Scalpel Size 12D****SM0518:** sterile, stainless
packaged 10/box**Swann Morton Disposable Scalpel Size 14****SM0519:** sterile, stainless
packaged 10/box**Swann Morton Disposable Scalpel Size 15****SM0505:** sterile, stainless
packaged 10/box**SM6605:** sterile, stainless
w/ guard
packaged 10/box**SM2335:** non-sterile, stainless
w/ guard
packaged 1000/box**Swann Morton Disposable Scalpel Size 15A****SM0520:** sterile, stainless
packaged 10/box**Swann Morton Disposable Scalpel Size 15C****SM0521:** sterile, stainless
packaged 10/box**Swann Morton Disposable Scalpel Size 15T****SM0592:** sterile, stainless
packaged 10/box

*Scalpels are not shown to actual size.

Swann Morton Disposable Scalpel Size 20**SM0506:** sterile, stainless
packaged 10/box**SM6606:** sterile, stainless
w/guard
packaged 10/box**SM2336:** non-sterile, stainless
w/guard
packaged 1000/box**Swann Morton Disposable Scalpel Size 21****SM0507:** sterile, stainless
packaged 10/box**SM6607:** sterile, stainless
w/ guard
packaged 10/box**SM2341:** non-sterile, stainless
w/guard
packaged 1000/box**Swann Morton Disposable Scalpel Size 22****SM0508:** sterile, stainless
packaged 10/box**SM6608:** sterile, stainless
w/ guard
packaged 10/box**Swann Morton Disposable Scalpel Size 23****SM0510:** sterile, stainless
packaged 10/box**SM6610:** sterile, stainless
w/ guard
packaged 10/box**Swann Morton Disposable Scalpel Size 24****SM0511:** sterile, stainless
packaged 10/box**SM6611:** sterile, stainless
w/ guard
packaged 10/box**Swann Morton Disposable Scalpel Size 26****SM0513:** sterile, stainless
packaged 10/box

Disposable Finger Scalpel Size 10

packaged 100/box

1110SM: Swann Morton
non-sterile, stainless



Disposable Finger Scalpel Size 10A

packaged 100/box

1110ASM: Swann Morton
non-sterile, stainless



Disposable Finger Scalpel Size 11

packaged 100/box

1111SM: Swann Morton
non-sterile, stainless



Disposable Finger Scalpel Size 15

packaged 100/box

1115SM: Swann Morton
non-sterile, stainless



*Scalpels are not shown to actual size.

Swann Morton Ref # to CS Part # Cross Reference

Swann Morton Reference #	Cincinnati Surgical Part #
0216	00SM6
0217	00SM9
0201	00SM10
0202	00SM10A
0203	00SM11
0291	00SM11P
0225	00SM11P
0263	00SM11P
0204	00SM12
0218	00SM12D
0239	00SM13
0219	00SM14
0205	00SM15
0220	00SM15A
0221	00SM15C
0292	00SM15T
0222	00SM16
0223	00SM18
0206	00SM20
0207	00SM21
0208	00SM22
0209	00SM22A
0210	00SM23
0211	00SM24
0212	00SM25
0215	00SM25A
0213	00SM26
0236	00SM36
0240	00SM40
0316	01SM6
0317	01SM9
0301	01SM10
0302	01SM10A
0390	01SM10R
0303	01SM11
0391	01SM11P
0325	01SM11P
0304	01SM12
0318	01SM12D
0339	01SM13
0319	01SM14
0305	01SM15
0320	01SM15A
0321	01SM15C
0322	01SM16
0323	01SM18
0324	01SM19
0306	01SM20
0307	01SM21
0308	01SM22
0309	01SM22A
0310	01SM23
0311	01SM24
0312	01SM25
0315	01SM25A
0313	01SM26
0314	01SM27

Swann Morton Reference #	Cincinnati Surgical Part #
0116	02SMV6
0101	02SMV10
0102	02SMV10A
0103	02SMV11
0191	02SMV11P
0104	02SMV12
0105	02SMV15
0106	02SMV20
0110	02SMV23
0111	02SMV24
0112	02SMV25
0115	02SMV25A
0113	02SMV26
2001	01C
2102	01M
5801	PD81
5802	PD82
5901	01SM61
5911	01SM61SB
5902	01SM62
5912	01SM62SB
5903	01SM63
5904	01SM64
5905	01SM65
5906	01SM65A
5907	01SM67
5908	01SM68
5909	01SM69
5921	01SP90
5922	01SP91
0517	SM0517
0501	SM0501
6601	SM6601
2331	SM2331
0502	SM0502
6602	SM6602
0503	SM0503
6603	SM6603
0591	SM0591
2391	SM2391
0504	SM0504
6604	SM6604
2334	SM2334
0518	SM0518
0519	SM0519
0505	SM0505
6605	SM6605
2335	SM2335
0520	SM0520
0521	SM0521
0592	SM0592
0506	SM0506
6606	SM6606
2336	SM2336
0507	SM0507
6607	SM6607
2341	SM2341

Swann Morton Reference #	Cincinnati Surgical Part #
0508	SM0508
6608	SM6608
0510	SM0510
6610	SM6610
0511	SM0511
6611	SM6610
0513	SM0513
2371	1110SM
2372	1110ASM
2373	1111SM
2375	1115SM
5701	01SM10K
5601	03SM10K
5703	01SM11K
5603	03SM11K
5791	01SM11PK
5691	03SM11PK
5705	01SM15K
5605	03SM15K
5706	01SM20K
5606	03SM20K
5707	01SM21K
5607	03SM21K
5708	01SM22K
5608	03SM22K
5710	01SM23K
5610	03SM23K
5711	01SM24K
5611	03SM24K
3901	05SM10
4001	06SM10
3991	05SM11P
4091	06SM11P
3905	05SM15
4005	06SM15
3906	05SM20
4006	06SM20
3907	05SM21
4007	06SM21
3908	05SM22
4008	06SM22
3910	05SM23
4010	06SM23
3911	05SM24
4011	06SM24
3915	05SM25
4015	06SM25
3601	SM3601
3501	SM3501
3603	SM3603
3503	SM3503
3691	SM3691
3591	SM3591
3605	SM3605
3505	SM3505
3606	SM3606
3506	SM3506

Swann Morton Reference #	Cincinnati Surgical Part #
3607	SM3607
3507	SM3507
3608	SM3608
3508	SM3508
3610	SM3610
3510	SM3510
3611	SM3611
3511	SM3511
0526	SM0526
0326	SM0326
0420	SM0420
0421	SM0421
0422	SM0422
3926	SM3926
4026	SM4026
3611	SM3611
3511	SM3511
2590	02SM22B
2560	02SM60
2561	02SM60B
2551	02PM40
2552	02PM40B
2201	SM2201
2203	SM2203
9940	SM9940
9942	SM9942
0527	SM5GD
9901	SM9901
9902	SM9902
9903	SM9903
9904	SM9904
9906	SM9906
9911	SM9911
9912	SM9912
0923	07B3
0933	073S
1033	073S-NU
0913	073L
0905	075M5B-S
1003	075M5B-E
0907	077S
0934	074S
1034	074S-NU
0914	074L
0906	075M6B-S
0906	075M6B-E
0639	07S
0640	07L
6051	07SF1
6061	07SF13
6062	07SF23
6053	07SF3
6054	07SF4
2609	0780SM-S
2618	0780SM-E
2652	07PM
2650	07PMH



Cincinnati Surgical is a leading manufacturer of high grade British surgical steel products. For more than 70 years we have provided our customers with quality products and a high level of customer service. Cincinnati Surgical is also known as one of the original manufacturers of stainless steel blades.

Product Features:

- Medium Surface Finish
- Packaged with VCI Paper to protect the blade from corrosion
- Narrow Grinding Angle resulting in increased initial keenness
- Strong Foil Package



Blades



Cincinnati Surgical Blade Size 10
packaged 100/box
0010: sterile, carbon
0110: sterile, stainless
0210: non-sterile, carbon
0410: non-sterile stainless (500/pkg)



Cincinnati Surgical Blade Size 11
packaged 100/box
0011: sterile, carbon
0111: sterile, stainless
0211: non-sterile, carbon
0411: non-sterile stainless (bulk - 500/pkg)



Cincinnati Surgical Blade Size 11P
packaged 500/pkg
0411P: non-sterile, stainless (500/pkg)



Cincinnati Surgical Blade Size 12
packaged 100/box
0012: sterile, carbon
0112: sterile, stainless
0212: non-sterile, carbon
0412: non-sterile stainless (bulk - 500/pkg)



Cincinnati Surgical Blade Size 12D
packaged 100/box
0112D: sterile, stainless



Cincinnati Surgical Blade Size 15T
packaged 100/box
0015: sterile, carbon
0115: sterile, stainless
0215: non-sterile, carbon
0415: non-sterile stainless (bulk - 500/pkg)



Cincinnati Surgical Blade Size 15C
packaged 100/box
0115C: sterile, stainless



Cincinnati Surgical Blade Size 20
packaged 100/box
0020: sterile, carbon
0120: sterile, stainless
0220: non-sterile, carbon



Cincinnati Surgical Blade Size 21
packaged 100/box
0021: sterile, carbon
0121: sterile, stainless
0221: non-sterile, carbon
0421: non-sterile stainless (500/pkg)



Cincinnati Surgical Blade Size 22
packaged 100/box
0022: sterile, carbon
0122: sterile, stainless
0222: non-sterile, carbon
0422: non-sterile stainless (bulk - 500/pkg)



Cincinnati Surgical Blade Size 23
packaged 100/box
0023: sterile, stainless
0123: sterile, stainless
0223: non-sterile, carbon
0423: non-sterile stainless (bulk - 500/pkg)



Cincinnati Surgical Blade Size 24
packaged 100/box
0224: non-sterile, carbon



CS Steel Blade Size 25A
packaged 100/box
0225A: non-sterile carbon

*Blades are not shown to actual size.

Cincinnati Surgical Disposable Scalpel Size 10

0510: sterile, stainless w/ guard 10/box

0610: non-sterile, stainless
w/ guard 100/box



Cincinnati Surgical Disposable Scalpel Size 11

0511: sterile, stainless w/ guard 10/box

0611: non-sterile, stainless
w/ guard 100/box



Cincinnati Surgical Disposable Scalpel Size 12

0512: sterile, stainless w/ guard 10/box

0612: non-sterile, stainless
100/box



Cincinnati Surgical Disposable Scalpel Size 15

0515: sterile, stainless w/ guard 10/box

0615: non-sterile, stainless
w/ guard 100/box



Cincinnati Surgical Disposable Scalpel Size 20

0520: sterile, stainless w/ guard 10/box

0620: non-sterile, stainless
w/ guard 100/box



Cincinnati Surgical Disposable Scalpel Size 21

0521: sterile, stainless w/ guard 10/box

0621: non-sterile, stainless
w/ guard 100/box



Cincinnati Surgical Disposable Scalpel Size 22

0522: sterile, stainless w/ guard 10/box

0622: non-sterile, stainless
w/ guard 100/box



Cincinnati Surgical Disposable Finger Scalpel Size 11P

packaged 100/box

1111: Cincinnati Surgical
non-sterile, stainless



*Scalpels are not shown to actual size.



Lance products enjoy a reputation of long lasting cutting edges. Processed from British “cold rolled” steel which is superior in tolerance and allows for wider grinding angles.

Product Features:

- 100% Visual Inspection
- Limited Range
- Wide Grinding Angle resulting in high durability
- CE Mark
- Low Surface Finish

Blades



Lance Blade Size 10
packaged 100/box
92010: sterile, carbon
92110: sterile, stainless



Lance Blade Size 11
packaged 100/box
92011: sterile, carbon
92111: sterile, stainless



Lance Blade Size 12
packaged 100/box
92012: sterile, carbon
92112: sterile, stainless



Lance Blade Size 15
packaged 100/box
92015: sterile, carbon
92115: sterile, stainless



Lance Blade Size 15
packaged 100/box
92015T: sterile, carbon
92115T: sterile, stainless



Lance Steel Blade Size 20
packaged 100/box
92020: sterile, carbon
92120: sterile, stainless



Lance Steel Blade Size 21
packaged 100/box
92021: sterile, carbon
92121: sterile, stainless



Lance Steel Blade Size 22
packaged 100/box
92022: sterile, carbon
92122: sterile, stainless



Lance Steel Blade Size 23
packaged 100/box
92023: sterile, carbon
92123: sterile, stainless



Lance Steel Blade Size 24
packaged 100/box
92024: sterile, carbon
92124: sterile, stainless



*Blades are not shown to actual size.

Lance Disposable Scalpel Size 10

92410: sterile, stainless
w/ guard 10/box

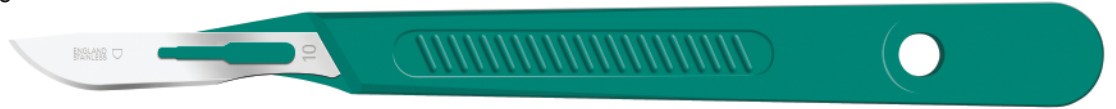

Lance Disposable Scalpel Size 11

92411: sterile, stainless
w/ guard 10/box
92711: non-sterile, stainless
w/ guard 100/box

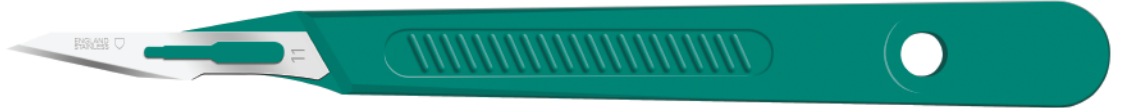

Lance Disposable Scalpel Size 12

92412: sterile, stainless
w/ guard 10/box

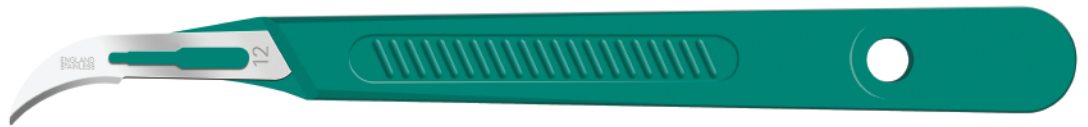

Lance Disposable Scalpel Size 15

92415: sterile, stainless
w/ guard 10/box
92715: non-sterile, stainless
w/ guard 100/box



Lance Disposable Scalpel Size 20

92420: sterile, stainless
w/ guard 10/box



Lance Disposable Scalpel Size 21

92421: sterile, stainless
w/ guard 10/box

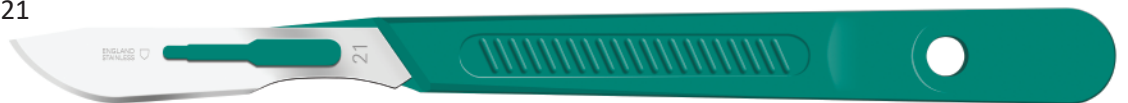

Lance Disposable Scalpel Size 22

92422: sterile, stainless
w/ guard 10/box

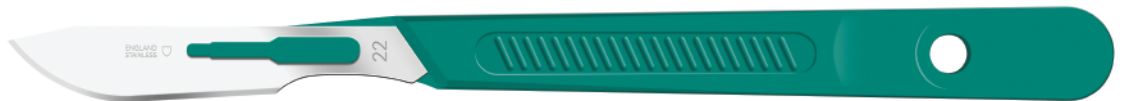

Lance Disposable Scalpel Size 23

92423: sterile, stainless
w/ guard 10/box



*Scalpels are not shown to actual size.

KLEEN Blade Management System by Swann-Morton®



Swann Morton Blade Size 10
01SM10K: sterile, stainless 50/box
03SM10K: non-sterile, stainless 500/box

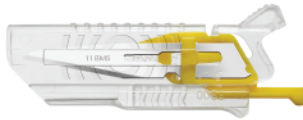

Swann Morton Blade Size 11
01SM11K: sterile, stainless 50/box
03SM11K: non-sterile, stainless 500/box

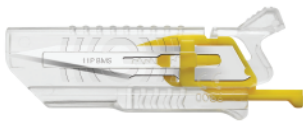

Swann Morton Blade Size 11P
01SM11PK: sterile, stainless 50/box
03SM11PK: non-sterile, stainless 500/box

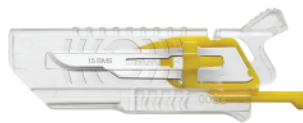

Swann Morton Blade Size 15
01SM15K: sterile, stainless 50/box
03SM15K: non-sterile, stainless 500/box



Swann Morton Blade Size 20
01SM20K: sterile, stainless 50/box
03SM20K: non-sterile, stainless 500/box

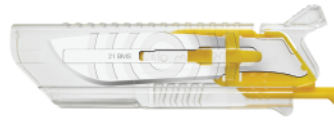

Swann Morton Blade Size 21
01SM21K: sterile, stainless 50/box
03SM21K: non-sterile, stainless 500/box

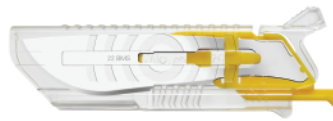

Swann Morton Blade Size 22
01SM22K: sterile, stainless 50/box
03SM22K: non-sterile, stainless 500/box

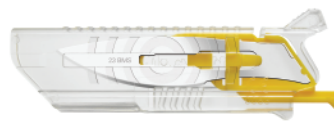

Swann Morton Blade Size 23
01SM23K: sterile, stainless 50/box
03SM23K: non-sterile, stainless 500/box

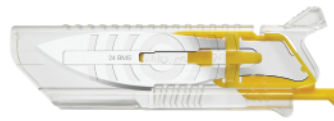

Swann Morton Blade Size 24
01SM24K: sterile, stainless 50/box
03SM24K: non-sterile, stainless 500/box

Compatible with standard #3 and #4 handles.
 No special handle needed.



Safety Scalpels Retracting Blade

Cincinnati Surgical Safety Scalpel Size 10
05S10: sterile, stainless 25/box

Swann Morton Safety Scalpel Size 10
05SM10: sterile, stainless 25/box
06SM10: non-sterile, stainless 500/box

Cincinnati Surgical Safety Scalpel Size 11P
05S11: sterile, stainless 25/box

Swann Morton Safety Scalpel Size 11P
05SM11P: sterile, stainless 25/box
06SM11P: non-sterile, stainless 500/box

Cincinnati Surgical Safety Scalpel Size 15
05S15: sterile, stainless 25/box

Swann Morton Safety Scalpel Size 15
05SM15: sterile, stainless 25/box
06SM15: non-sterile, stainless 500/box



*Items are not shown to actual size.

Safety Scalpels Retracting Blade

14

Swann Morton Safety Scalpel Size 20

05SM20: sterile, stainless 25/box

06SM20: non-sterile, stainless 500/box



Swann Morton Safety Scalpel Size 21

05SM21: sterile, stainless 25/box

06SM21: non-sterile, stainless 500/box



Swann Morton Safety Scalpel Size 22

05SM22: sterile, stainless 25/box

06SM22: non-sterile, stainless 500/box



Swann Morton Safety Scalpel Size 23

05SM23: sterile, stainless 25/box

06SM23: non-sterile, stainless 500/box



Swann Morton Safety Scalpel Size 24

05SM24: sterile, stainless 25/box

06SM24: non-sterile, stainless 500/box



Swann Morton Safety Scalpel Size 25A

05SM25: sterile, stainless 25/box

06SM25: non-sterile, stainless 500/box



Safety Stitch Cutter

Swann Morton Safety Stitch Cutter

SM3926: sterile, stainless 25/box

SM4026: non-sterile, stainless 500/box



*Items are not shown to actual size.

Safety Scalpels Retracting Guard

15

Swann Morton Safety Scalpel Size 10
SM3601: sterile, stainless 10/box
SM3501: non-sterile, stainless 500/box



Swann Morton Safety Scalpel Size 11
SM3603: sterile, stainless 10/box
SM3503: non-sterile, stainless 500/box



Swann Morton Safety Scalpel Size 11P
SM3691: sterile, stainless 10/box
SM3591: non-sterile, stainless 500/box



Swann Morton Safety Scalpel Size 15
SM3605: sterile, stainless 10/box
SM3505: non-sterile, stainless 500/box



Swann Morton Safety Scalpel Size 20
SM3606: sterile, stainless 10/box
SM3506: non-sterile, stainless 500/box



Swann Morton Safety Scalpel Size 21
SM3607: sterile, stainless 10/box
SM3507: non-sterile, stainless 500/box



Swann Morton Safety Scalpel Size 22
SM3608: sterile, stainless 10/box
SM3508: non-sterile, stainless 500/box

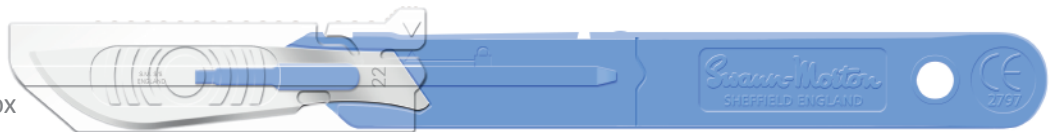

Swann Morton Safety Scalpel Size 23
SM3610: sterile, stainless 10/box
SM3510: non-sterile, stainless 500/box



Swann Morton Safety Scalpel Size 24
SM3611: sterile, stainless 10/box
SM3511: non-sterile, stainless 500/box



Safety Stitch Cutter

Swann Morton Safety Scalpel Size 22
SM3611: sterile, stainless 10/box
SM3511: non-sterile, stainless 500/box





QuickSmart BladeFlask
48QS: packaged individually

Removes standard sized surgical blades size 6 - 27



QuickSmart BladeFlask EVO
48EVO: packaged individually

Removes all standard sized surgical blades including size 60 and 70 blades



QuickSmart BladeFlask Bracket
48QSB: packaged individually

For Use on both versions of the BladeFlask blade remover.

Aunex Blade Remover
48CS: packaged individually

Removes all standard sized surgical blades including size 60 and 70 blades

Holds up to 200 blades (This number will vary based on the size of the blade being removed.)



Single Use Blade Remover
48SM: Non-sterile, packaged 100/box
48SMS: Sterile, packaged 50/box

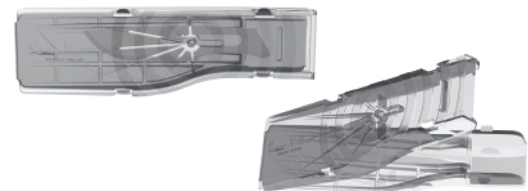

Removes standard sized surgical blades size 6 - 27

Cincinnati Surgical Blade Remover
48: packaged 10/box



Fits 100 blades

Removes standard sized surgical blades size 6 - 27

Ampoule Openers
1042R: Snap-It Regular (1-15ml) 10/box
1042L: Snap-It Large (5-25ml) 10/box



*Items are not shown to actual size.

Swann Morton Disposable Stitch Cutter Scalpel

SM0526: sterile, stainless 10/box



Cincinnati Surgical Stitch Cutter

44: sterile, stainless 100/box



Swann Morton Stitch Cutter Blade

SM0326: sterile, stainless blade 100/box
Fits any #3 fitment handle



Swann Morton Stitch Cutter

SM0420: sterile, carbon, short 100/box



Swann Morton Stitch Cutter

SM0421: sterile, stainless, long 100/box

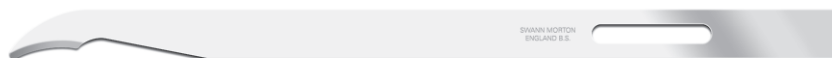

Swann Morton Stitch Cutter

SM0422: sterile, stainless, midi 100/box



Swann Morton Safety Stitch Cutter Retracting Blade

SM3926: sterile, stainless 25/box

SM4026: non-sterile, stainless 500/box



Swann Morton Safety Stitch Cutter Retracting Guard

SM3611: sterile, stainless 10/box

SM3511: non-sterile, stainless 500/box



*Items are not shown to actual size.



Swann Morton Blade Size 22B
packaged 100/box
02SM22B: non-sterile, carbon

Fits Handles: 074S; 07SM6B-E
07SM6B-S



Cincinnati Surgical Blade Size 60
packaged 100/box
0260: non-sterile, carbon
(plastic wrapped strips of 4)

Fits Handles: 0780SM-E
0780SM-S



Cincinnati Surgical Blade Size 60
packaged 100/box
0260CS: non-sterile, carbon
(individually foil wrapped)

Fits Handles: 0780SM-E
0780SM-S



Cincinnati Surgical Blade Size 70
packaged 100/box
0270: non-sterile, carbon

Fits Handles: 0780SM-E
0780SM-S



Swann Morton Blade Size 60
packaged 50/box
02SM60: non-sterile, carbon

Fits Handles: 0780SM-E
0780SM-S



Swann Morton Blade Size 60B
packaged 50/box
02SM60B: non-sterile, carbon

Fits Handles: 0780SM-E
0780SM-S



Swann Morton Blade Size 40
packaged 10/box
02PM40: non-sterile, carbon

Fits Handles: 07PM, 07PMH



Swann Morton Blade Size 40B
packaged 10/box
02PM40B: non-sterile, carbon

Fits Handles: 07PM, 07PMH

Disposable Knife Size 40
packaged individually
06PM40: non-sterile, carbon



*Items are not shown to actual size.

Swann Morton Skin Graft Blade SG3

packaged 20/box
SM2201: sterile, stainless

Fits Handles:
 073S, 073L



Swann Morton Skin Graft Blade SGD

packaged 20/box
SM2203: sterile, stainless

Fits Handles:
 073S, 073L



Swann Morton Skin Graft Blade 158MM

packaged 10/box
SM9940: sterile, stainless

Fits Handles:
 SM9901, SM9902,
 SM9903



Swann Morton Skin Graft Blade Silvers

packaged 10/box
SM9942: sterile, stainless

Fits Handle:
 SM9911



Swann Morton Disposable Double Edged SGD Scalpel

packaged 10/box
SMSGD: sterile, stainless



Swann Morton Braithwaite Handle

SM9901: stainless handle
SM9904: stainless handle with
 2 boxes of SM9940



Swann Morton Cobbett Handle

SM9902: stainless handle

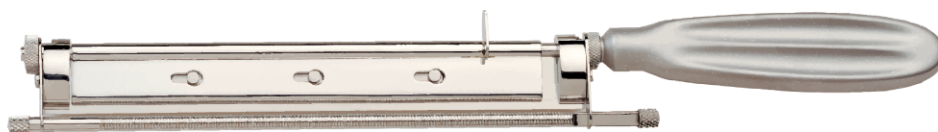

Swann Morton Watson Handle

SM9903: stainless handle
SM9906: stainless handle with
 2 boxes of SM9940

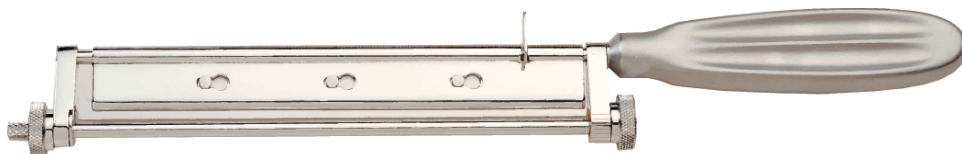

Swann Morton Silvers Handle

SM9911: stainless, blue handle



Swann Morton Silvers Handle

SM9912: stainless handle

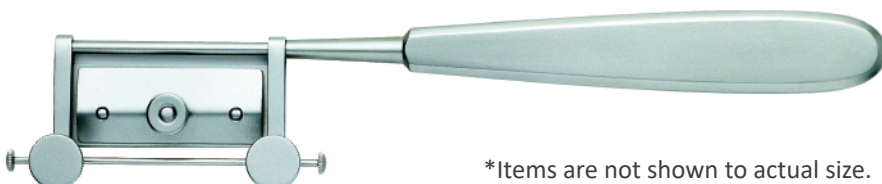

*Items are not shown to actual size.

#3 Fitment Handles

Handle Size 3

07B3: stainless, lightweight
Fits Blades 6 - 16



Handle Size 3

073S: stainless
Fits Blades 6 - 16
UDI Compliant

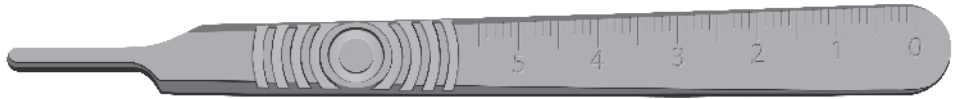

Handle Size 3

073S-NU: stainless
Fits Blades 6 - 16



Handle Size 3 Long

073L: stainless
Fits Blades 6 - 16
UDI Compliant



Handle Size 3 Slim

07SM9: stainless
Fits Blades 6 - 16
UDI Compliant



Handle Size 5

07SM5B-S: stainless
Fits Blades: 6 - 16
UDI Compliant



Handle Size 5

07SM5B-E: stainless
Fits Blades: 6 - 16



Handle Size 7

077S: stainless
Fits Blades: 6 - 16
UDI Compliant



*Handles are not shown to actual size.

#4 Fitment Handles

Handle Size 4

074S: stainless
Fits Blades 20-26
UDI Compliant

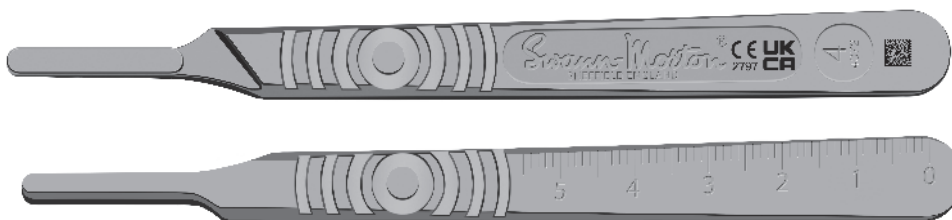

Handle Size 4

074S-NU: stainless
Fits Blades 20-26



Handle Size 4 Long

074L: stainless
Fits Blades 20-26
UDI Compliant



Handle Size 6

07SM6B-S: stainless
Fits Blades: 20 - 26
UDI Compliant



Handle Size 6

07SM6B-E: ergonomic
Fits Blades: 20 - 26



Major Handle

07L: stainless, long
Fits Blade: 01C
UDI Compliant



Major Handle

07S: stainless, standard
Fits Blade: 01C
UDI Compliant



*Handles are not shown to actual size.

Miniature Handle Size 13cm

07SF1: stainless
Fits Blades: 01M and 61-91

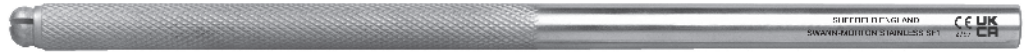

Miniature Handle Size 13cm

07SF13: stainless, quick release feature
Fits Blades: 01M and 61-91



Miniature Handle Size 10cm

07SF23: stainless, quick release feature
Fits Blades: 01M and 61-91



Miniature Handle Size 7.5cm

07SF3: stainless
Fits Blades: 01M and 61-91



Miniature Handle Size 5cm

07SF4: stainless
Fits Blades: 01M and 61-91



Handle

0780SM-E: ergonomic, pathology/post mortem
Fits Blades: 0260, 0260CS, 02SM60
02SM60B and 0270



Handle

0780SM-S: stainless, pathology/post mortem
Fits Blades: 0260, 0260CS, 02SM60
02SM60B and 0270



Handle Size PM40

07PM: stainless, pathology/post mortem
Fits Blades: PM40 and PM40B



Handle Size PM40

07PMH: stainless, pathology/post mortem
Fits Blades: PM40 and PM40B



*Handles are not shown to actual size.

Post Mortem Needles 3/8 Circle Cutting Edge

08816: non-sterile, stainless
12/pkg

Available Sizes	Dimensions
3	1.42mm x 75mm
4	1.80mm x 100mm
5	2.00mm x 125mm
6	2.00mm x 152mm

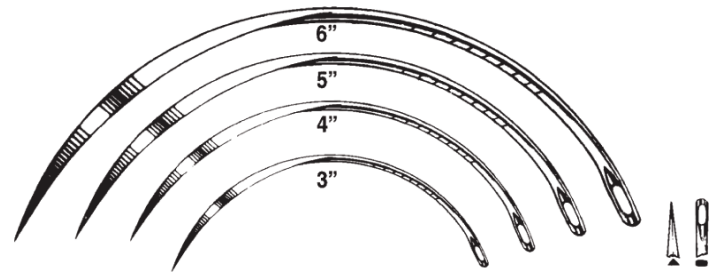

Straight Cutting Needles Triangular Point

08817: non-sterile, stainless
12/pkg

Available Sizes	Dimensions
2	1.02mm x 2"
3	1.27mm x 3"
4	1.42mm x 4"

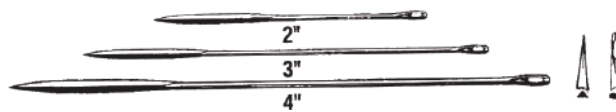

Post Mortem Needles Serpentine Double Curved Cutting Edge

08819: non-sterile, stainless
12/pkg

Available Sizes	Dimensions
0	5"
1	4.75"
2	4.25"
3	3.25"
4	2.25"

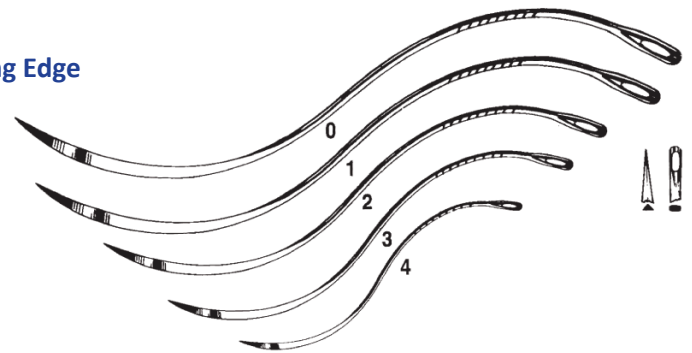

Post Mortem Needles Half Curved Cutting Edge

08820: non-sterile, stainless
12/pkg

Available Sizes	Dimensions
00	2.20mm x 150mm
0	2.20mm x 140mm
1	2.00mm x 114mm
2	1.8mm x 89mm

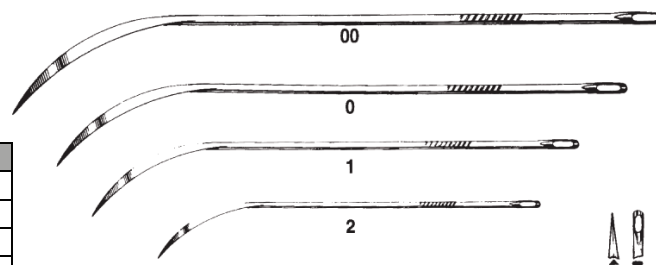

All non-sterile
needles are sold
in multiples of
10 dozen.

Regular Surgeon Needles Half Curved Cutting Edge

08821: non-sterile, stainless
12/pkg

Available Sizes	Dimensions
1	1.21mm x 80mm
2	1.20mm x 68mm
4	1.20mm x 64mm
6	1.10mm x 55mm
8	1.00mm x 50mm
10	.93mm x 43mm
12	.76mm x 35mm
14	.69mm x 29mm
16	.60mm x 27mm
18	.64mm x 25mm
20	.53mm x 22mm
22	.50mm x 19mm

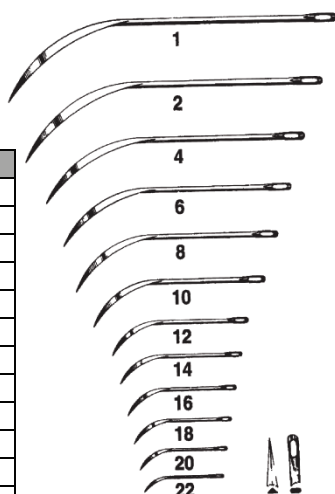

Regular Surgeon Needles 3/8 Circle Cutting Edge

08822: non-sterile, stainless
12/pkg

Available Sizes	Dimensions
1	1.20mm x 80mm
2	1.22mm x 68mm
4	1.21mm x 64mm
6	1.10mm x 55mm
8	1.00mm x 50mm
10	.94mm x 43mm
12	.76mm x 35mm
14	.69mm x 29mm
16	.64mm x 27mm
18	.53mm x 22mm
20	.48mm x 17mm

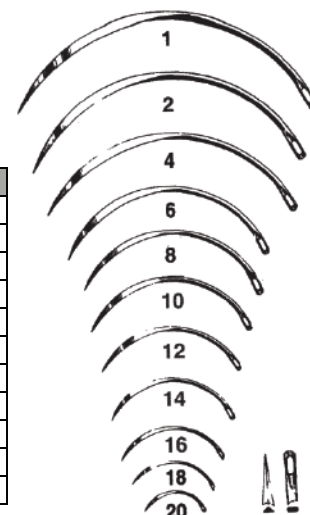

Regular Surgeon Needles 3/8 Circle Taper Point

08822T: non-sterile, stainless
12/pkg

Available Sizes	Dimensions
4	1.16mm x 65mm
6	1.09mm x 55mm
12	.76mm x 35mm
14	.69mm x 29mm
16	.64mm x 27mm
18	.53mm x 22mm

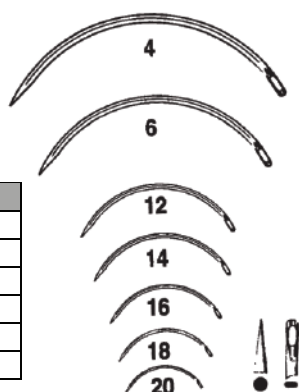

Mayo's Catgut Needles 1/2 Circle Taper Point

08824: non-sterile, stainless
12/pkg

Available Sizes	Dimensions
2	1.40mm x 45mm
3	1.40mm x 38mm
4	1.40mm x 35mm
6	1.30mm x 28mm

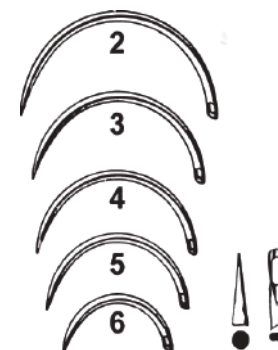

09824: sterile, stainless
50/box

Available Sizes	Dimensions
2	1.40mm x 45mm
3	1.40mm x 38mm
4	1.40mm x 35mm
5	1.30mm x 32mm
6	1.30mm x 28mm

Mayo's Catgut Needles 1/2 Circle Trocar Point

09826: sterile, stainless
50/box

Available Sizes	Dimensions
2	1.40mm x 45mm
3	1.40mm x 38mm
4	1.40mm x 35mm
5	1.30mm x 32mm
6	1.30mm x 28mm

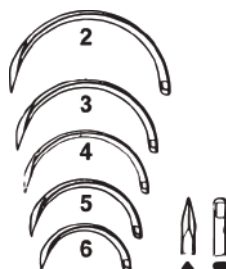

Keith's Straight Abdominal Needles Triangular Point

08827: non-sterile, stainless
12/pkg

Available Sizes	Dimensions
1 1/2	.74mm x 38mm
1 3/4	.75mm x 44mm
2	.76mm x 51mm
2 1/2	.81mm x 64mm
2 7/8	.92mm x 76mm
3 7/8	1.00mm x 95mm

09827: sterile, stainless
50/box

Available Sizes	Dimensions
2	.76mm x 51mm
2 1/2	.81mm x 64mm
2 7/8	.83mm x 76mm

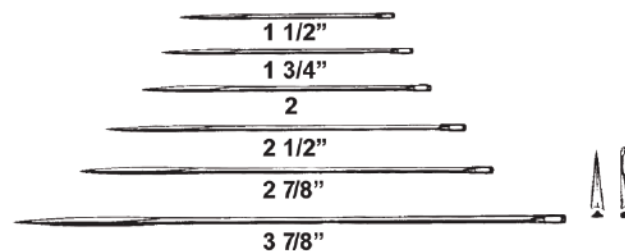

All non-sterile
needles are sold
in multiples of
10 dozen.

*Needles are not shown to actual size.

Eye Needles

3/8 Circle Cutting Edge

08830: non-sterile, stainless
12/pkg

Available Sizes	Dimensions
1	.53mm x 28mm
2	.53mm x 22mm



All non-sterile needles are sold in multiples of 10 dozen.

Fistula Needles

1/2 Circle Cutting Edge

08832: non-sterile, stainless
12/pkg

Available Sizes	Dimensions
0	1.42mm x 64mm
9	.76mm x 19mm



Regular Surgeon Needles

1/2 Circle Cutting Edge

08834: non-sterile, stainless
12/pkg

Available Sizes	Dimensions
00	1.20mm x 68mm
0	1.20mm x 64mm
1	1.09mm x 59mm
2	1.00mm x 50mm
4	.90mm x 43mm
6	.68mm x 29mm
7	.60mm x 27mm
8	.55mm x 21mm
9	.50mm x 19mm

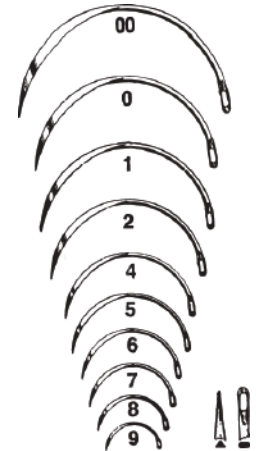

Regular Surgeon Needles

1/2 Circle Taper Point

08834T: non-sterile, stainless
12/pkg

Available Sizes	Dimensions
0	1.20mm x 64mm
2	1.00mm x 50mm
4	.90mm x 43mm
6	.68mm x 29mm
9	.53mm x 19mm

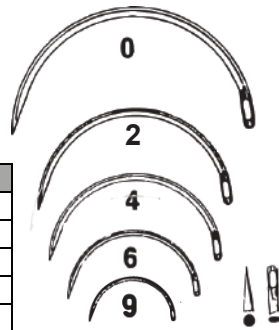

Mayo's Intestinal Needles

3/8 Circle Taper Point

08837: non-sterile, stainless
12/pkg

Available Sizes	Dimensions
1	.53mm x 25mm



Ferguson's Needles

1/2 Circle Taper Point

08842: non-sterile, stainless
12/pkg

Available Sizes	Dimensions
2	1.27mm x 70mm
4	1.22mm x 60mm
6	1.10mm x 55mm
8	.92mm x 44mm
10	.92mm x 39mm
12	.76mm x 35mm
14	.76mm x 29mm
16	.70mm x 25mm
18	.53mm x 19mm
20	.64mm x 15mm

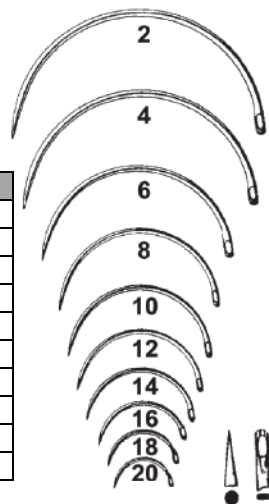

Lane's Cleft Palate Needles

1/2 Circle Cutting Edge

08844: non-sterile, stainless
12/pkg

Available Sizes	Dimensions
1	.71mm x 25mm



*Needles are not shown to actual size.

Loopuyt's Cutting Edge Needles

08846: non-sterile, stainless
12/pkg

Available Sizes	Dimensions
1	1.42mm x 80mm
2	1.22mm x 68mm
3	1.10mm x 60mm
4	1.00mm x 52mm
5	1.00mm x 46mm

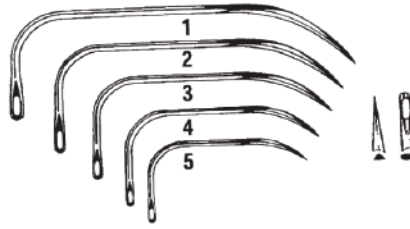

All non-sterile
needles are sold
in multiples of
10 dozen.

Lane's Cleft Palate Needles 3/8 Circle Cutting Edge

08848: non-sterile, stainless
12/pkg

Available Sizes	Dimensions
1	.71mm x 22mm
2	.69mm x 19mm
2	.69mm x 16mm



Davis Tonsil Needles 1/2 Circle Taper Point

09849: sterile, stainless
50/box

Available Sizes	Dimensions
one size	1.20mm x 25mm



Martin's Uterine Needles 1/2 Circle Cutting Edge

08860: non-sterile, stainless
12/pkg

Available Sizes	Dimensions
1	1.60mm x 74mm



Regular Surgeon Needles 3/8 Circle Reverse Cutting Edge

08922: non-sterile, stainless
12/pkg

Available Sizes	Dimensions
6	1.10mm x 55mm
8	1.00mm x 50mm
10	.93mm x 43mm
12	.76mm x 35mm
14	.69mm x 29mm
16	.64mm x 27mm
18	.53mm x 22mm

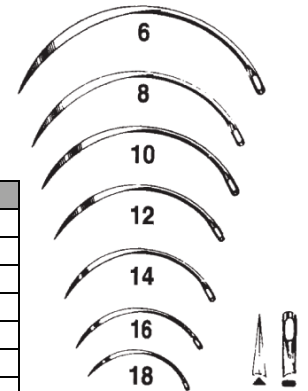

Regular Surgeon Needles 1/2 Circle Reverse Cutting Edge

08934: non-sterile, stainless
12/pkg

Available Sizes	Dimensions
3	1.00mm x 50mm
5	.85mm x 38mm
7	.60mm x 27mm

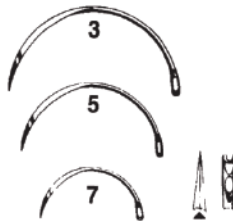



Raising the Standard™

Sustainability Commitment

Working Toward NET ZERO by 2050

Strategy

As the global leader in surgical blade manufacturing, we have a responsibility to continue raising the standard of the manufacturing process including being environmentally conscience in our processes. We have the opportunity to integrate sustainability efforts into all aspects of our business to ensure a positive social impact.

Swann Morton, our manufacturing partner in Sheffield, developed a Sustainability and Social Impact Strategy with the goal of net zero emissions by 2050. This includes an in-depth Greenhouse Gas Protocol and the following list of accomplishments already in place.

Swann-Morton Initiatives To Date:

Continual Improvement

Swann Morton continues to design, build, and install more energy efficient production machinery. The most recently developed models utilize at least 50% less compressed air.

Significant Reduction In Packaging Materials

Swann-Morton reduced the size of its packaging by 20% and discontinued the use of plastic cellophane wrapping. By implementing these changes Swann Morton now saves approximately 80,680m² per year on foils and plastic cellophane combined – the equivalent of 11 football fields.

Recycled Raw Materials

Over the last 3 years, 37% of all steel used to manufacture Swann Morton, Cincinnati Surgical and Lance blades and scalpels came from recycled content.



Swann-Morton®

Cincinnati Surgical and Swann Morton entered into a historic co-manufacturing agreement in 2015, combining our manufacturing capabilities in the Swann Morton Sheffield England facility. Our sustainability efforts are all a part of raising the standard for surgical blades worldwide.



ENMS 633525



EMS 633531

Scan for Our Energy Policies





Raising the Standard™

THE SHARPEST, MOST PRECISE,
MOST DURABLE BLADES FOR OVER

80 YEARS

CincinnatiSurgical.com